

Laubabscheider

- (GB) Leaves-Seperator (F) Séparatuer de feuilles
- (NL) Bladafscheider (S) Lövvaskiljare
- (I) Separatore per loghe (E) Separador de hojas
- (P) Separador de folhas

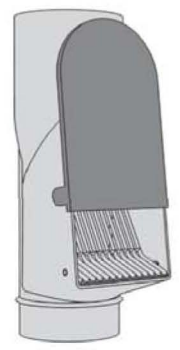

2000210
2000120

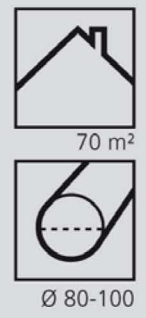

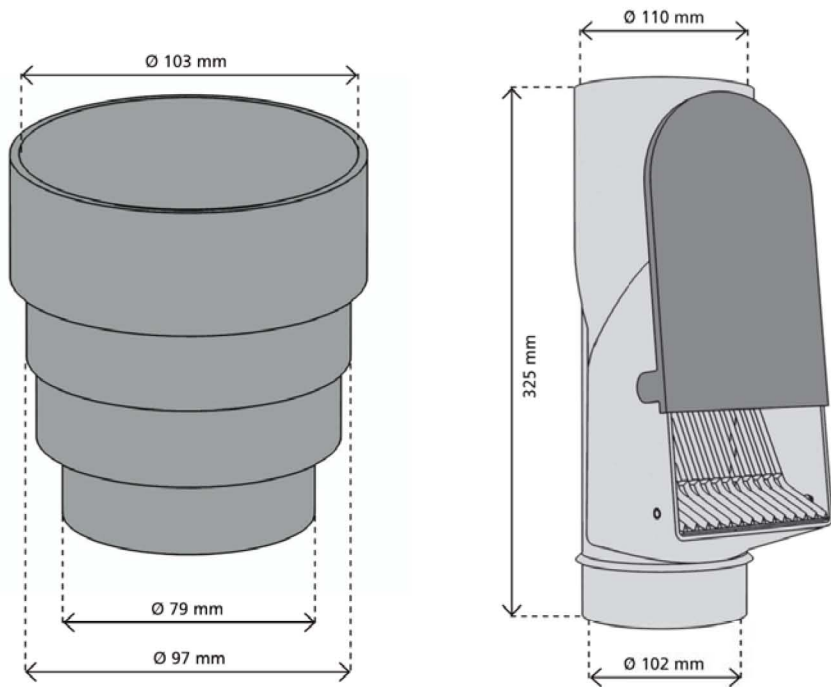

2.

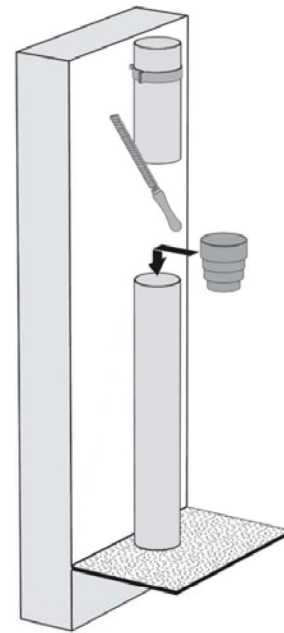

3.

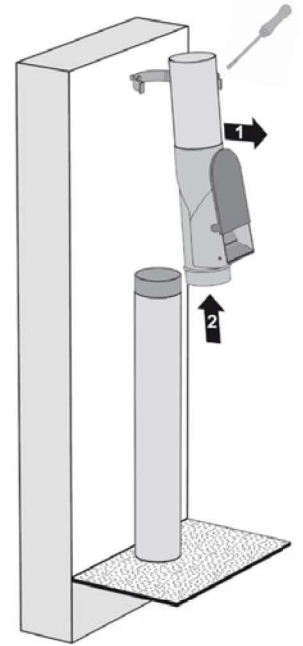

1.

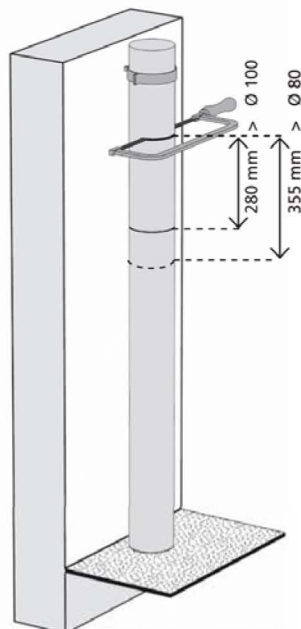

4.

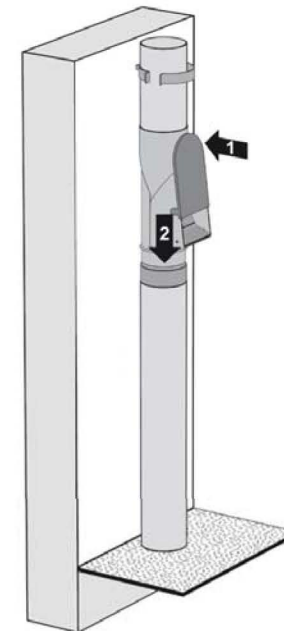

5.

